

## Axial Fan Connections

Duct connections are an important aspect of all fan installations, but they are especially an important consideration for axial fan duct systems. Axial fans will typically take up less room for a given flow and pressure than other fan types. As a result the velocity of the air going through axial fans is higher. If care is not taken in designing good duct connections, this can cause performance problems that may not show up with other fan types. Also, if the techniques shown in this paper are used wisely, it is often possible to improve the performance of axial fans.

### System Effects

When testing fans in the laboratory to generate the catalog performance data, the test setups used provide the fan ideal conditions for optimum performance. If there are any inlet connections on the fan inlet, they are designed so that the flow has a uniform velocity profile with minimum turbulence. This ensures that the impeller has uniform loading on all fan blades and around the entire circumference of the impeller. If the fan is rated for outlet duct connections, a straight duct with sufficient length for pressure recovery is mounted to the fan outlet.

When installations do not provide uniform flow on the inlet and do not have a sufficient length of outlet duct for pressure recovery, fans do not perform at the catalog level. The decrease in performance is known as 'system effect'. System effects are described in greater detail in ED-100 "Fan Performance Troubleshooting Guide" and in AMCA Publication 201 "Fans and Systems."

The best and most energy efficient practice is to design the duct system and select the fan so that there are no system effects. Often, because of space constraints this is not possible. In these cases, AMCA Publication 201 is an excellent resource because it contains methods to estimate system effects for a wide range of common duct configurations that cause system effect.

### Impact Loss

#### Standard Configuration

Axial fans tested using AMCA standards typically use a test setup similar to the one shown in Figure 1. The inlet bell provides uniform flow at the inlet and simulates a ducted inlet. The straight duct allows for pressure recovery, the importance of which will be demonstrated later. The catalog flow and pressure are measured at the location labeled '2' in the figure.

While this setup represents the most common type of axial fan installation and it makes sense to rate fans with this type of setup, there is a loss built into it. In the center of most axial fans there is an inner shell that contains the motor on direct driven fans or the bearings

on belt driven fans. The air flows through the annular area between the inner shell and the outer shell. In some fans the velocity in this area can get quite high, 8000 fpm or more. When the air reaches the end of the inner shell there is an abrupt expansion as the air tries to fill the hollow core downstream on the inner shell. The loss associated with this abrupt expansion is known as 'impact loss'.

Figure 1. Typical Axial Fan Test Setup Configuration

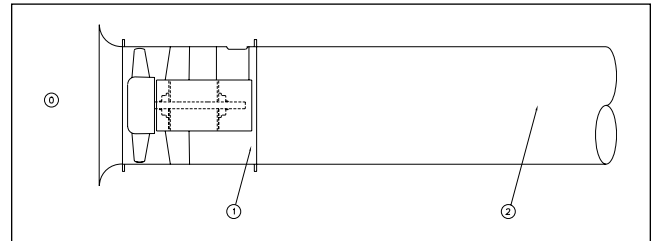

Figure 1 shows a 32" diameter vaneaxial fan, tested and rated in this configuration, operating at 25,000 cfm at 4.50 in. w.g. static pressure and 2140 rpm. Locations that are important in understanding what is happening in the fan and system are labeled on the figure - station 0 is at the inlet, station 1 is at the end of the inner shell and station 2 is downstream in the duct far enough so that there is full pressure recovery. At station 0 there is no velocity, the static pressure is zero and as a result the velocity and total pressures are also zero. The flow and pressure of the fan is measured at station 2.

We also know the areas so we can calculate the velocities and velocity pressures at stations 1 and 2.

$$\text{Given: } Q = 25,000 \text{ cfm} \quad P_{S2} = 4.50 \text{ in. w.g.} \\ P_{S0} = P_{V0} = P_{T0} = 0.00 \text{ in. w.g.} \quad \rho = 0.075 \text{ lb./cu. ft.}$$

$$A_1 = 3.71 \text{ ft}^2 \quad V_1 = Q / A_1 = 6741 \text{ fpm} \\ P_{V1} = \rho (V_1 / 1096)^2 = 2.83 \text{ in. w.g.}$$

$$A_2 = 5.67 \text{ ft}^2 \quad V_2 = Q / A_2 = 4407 \text{ fpm} \\ P_{V2} = \rho (V_2 / 1096)^2 = 1.21 \text{ in. w.g.}$$

We can also calculate the total pressure at station 2:

$$P_{T2} = P_{S2} + P_{V2} = 4.50 + 1.21 = 5.71 \text{ in. w.g.}$$

The equation for the impact loss (IP) for figure 1 is:

$$IP_1 = \rho \left( \frac{V_1 - V_2}{1096.2} \right)^2$$

$$IP_1 = 0.34 \text{ in. w.g.}$$

We can now calculate the pressures at station 1 since the impact loss is the loss in total pressure between station 1 and station 2.

$$Pt_1 = Pt_2 + IP_1 = 5.71 + 0.34 = 6.05 \text{ in. w.g.}$$

$$Ps_1 = Pt_1 - Pv_1 = 3.22 \text{ in. w.g.}$$

## Fan Connected to Large Outlet Duct

Figure 2 shows the same fan as Figure 1 only this time it is connected to a 42" diameter duct. This makes the expansion even more abrupt, since the air not only has to fill the hollow core but needs to expand outward as well.

Figure 2. Axial Fan Connected to Large Outlet Duct

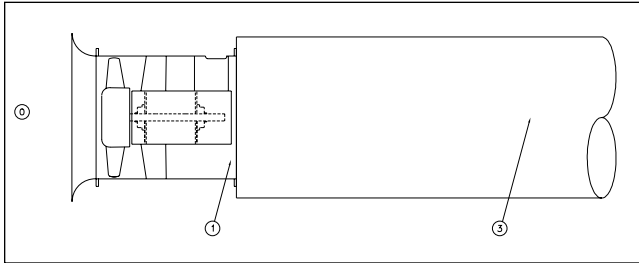

The flow and fan speed is the same as Figure 1, so the pressures at stations 0 and 1 remain the same. Because the area at station 3 in Figure 2 is greater than the area at station 2 in Figure 1, more of the velocity pressure at station 1 is converted to static pressure, but there is also more impact loss.

For this example,

$$A_3 = 9.62 \text{ ft}^2 \quad V_3 = Q / A_3 = 2598 \text{ fpm}$$

$$Pv_3 = \rho (V_3 / 1096)^2 = 0.42 \text{ in. w.g.}$$

The equation for impact loss (IP) for Figure 2 is:

$$IP_2 = \rho \left( \frac{V_1 - V_3}{1096.2} \right)^2$$

$$IP_2 = 1.07 \text{ in. w.g.}$$

Calculating the pressures at point 3:

$$Pt_3 = Pt_1 - IP_2 = 6.05 - 1.07 = 4.98 \text{ in. w.g.}$$

$$Ps_3 = Pt_3 - Pv_3 = 4.56 \text{ in. w.g.}$$

Comparing Figure 2 with Figure 1, we see that in Figure 2 we slow the air down to a lower velocity, therefore converting more of the velocity pressure at station 1 into static pressure. This results in the static pressure downstream of the fan being higher in Figure 2 than in Figure 1. But because this greater expansion occurs abruptly, overall more energy is lost in the airstream and the total pressure downstream is less in Figure 2 than in Figure 1.

Figure 3. Axial Fan Connected to Large Outlet Plenum or No Outlet Duct

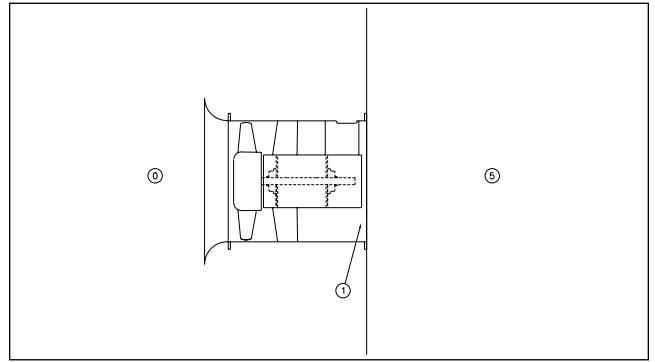

## Fan Connected to Large Outlet Plenum or No Outlet Duct

Figure 3 takes Figure 2 to an extreme, to the point where the velocity downstream of the fan is so low that for all practical purposes it is zero.

$$V_5 = 0 \text{ fpm} \quad Pv_5 = 0.00 \text{ in. w.g.}$$

For Figure 3 the impact loss is:

$$IP_3 = \rho \left( \frac{V_1}{1096.2} \right)^2$$

$$IP_3 = 2.83 \text{ in. w.g.}$$

$$Pt_5 = Pt_1 - IP_3 = 6.05 - 2.83 = 3.22 \text{ in. w.g.}$$

$$Ps_5 = Pt_5 - Pv_5 = 3.22 \text{ in. w.g.}$$

In this case the expansion is so abrupt that all of the velocity pressure at station 1 is lost - none of it is converted to static pressure. As a result both the static pressure and total pressure downstream of the fan is much less than Figure 1.

Note that pressure is directly related to energy and the impact loss represents wasted energy. In this example, with a loss of 2.83 in. w.g. and 25,000 cfm, 11 hp is wasted. This example demonstrates how important it is to have ductwork downstream of axial fans.

Figure 4. Axial Fan Connected to Ducted Outlet Cone

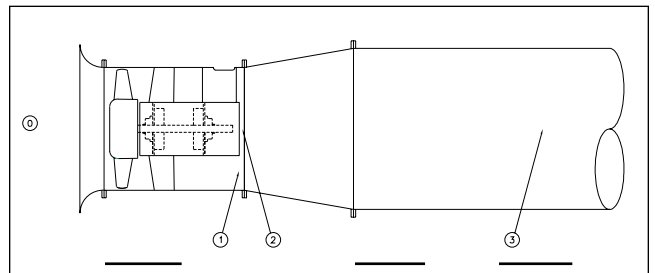

## Fan Connected to Ducted Outlet Cone

Figure 4 shows a fan with an outlet cone connected to the outlet of the fan and ductwork connected to the outlet of the cone. In this case the impact loss due to filling the hollow core is still present, but adding an outlet cone minimizes the impact loss due to the outward expansion. In order to get benefit from the outlet

cone it is important to keep the taper angle shallow (15° or less per side) so that the flow does not separate from the walls of the cone. If the flow separates, the impact loss is similar to Figure 2.

For Figure 4 the equation for impact loss is:

$$IP_4 = \rho \left( \frac{V_1 - V_2}{1096.2} \right)^2 + \rho (1-\eta) \left[ \left( \frac{V_2}{1096.2} \right)^2 - \left( \frac{V_3}{1096.2} \right)^2 \right]$$

The first term in this equation is the same as the Figure 1 expansion from the annular area to the fan outlet area. The second term is the loss through the outlet cone. The term  $\eta$  is the efficiency of the cone. For a cone with a taper angle of 15°, the efficiency is approximately 85% ( $\eta = 0.85$ ).

For our example, with a 42" diameter duct, the velocities and velocity pressures remain the same as the previous examples. The impact loss is then:

$$IP_4 = 0.46 \text{ in. w.g.}$$

$$Pt_3 = Pt_1 - IP_4 = 6.05 - 0.46 = 5.59 \text{ in. w.g.}$$

$$Ps_3 = Pt_3 - Pv_3 = 5.17 \text{ in. w.g.}$$

Comparing this result with the one from Figure 2 shows that the addition of the cone allows the fan to generate 0.61 in. w.g. more pressure.

Figure 5. Axial Fan Connected to a Ducted Outlet Cone with Center Body

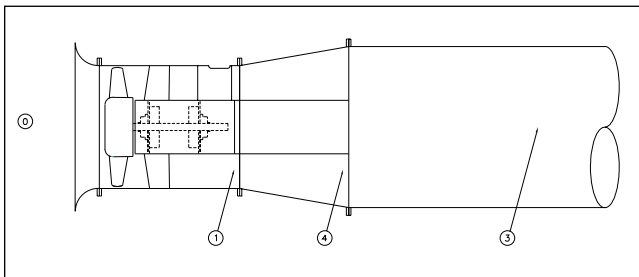

## Fan Connected to a Ducted Outlet Cone with Center Body

Figure 5 shows a setup similar to Figure 4 except that a center body has been added to the outlet cone. Adding the center body reduces the impact loss due to filling the hollow core because the annular velocity at the end of the cone is lower than at the end of the fan housing. This feature is built into many axial silencer designs.

For this case the impact loss is:

$$IP_5 = \rho \left( \frac{V_4 - V_3}{1096.2} \right)^2 + \rho (1-\eta) \left[ \left( \frac{V_1}{1096.2} \right)^2 - \left( \frac{V_4}{1096.2} \right)^2 \right]$$

$$IP_5 = 0.35 \text{ in. w.g.}$$

$$Pt_3 = Pt_1 - IP_5 = 5.28 - 0.26 = 5.70 \text{ in. w.g.}$$

$$Ps_3 = Pt_3 - Pv_3 = 5.27 \text{ in. w.g.}$$

Adding the center body to the cone allows the fan to generate 0.53 in. w.g. more pressure than the cone without the center body.

Figure 6. Axial Fan Connected to a Non-Ducted Outlet Cone with Center Body

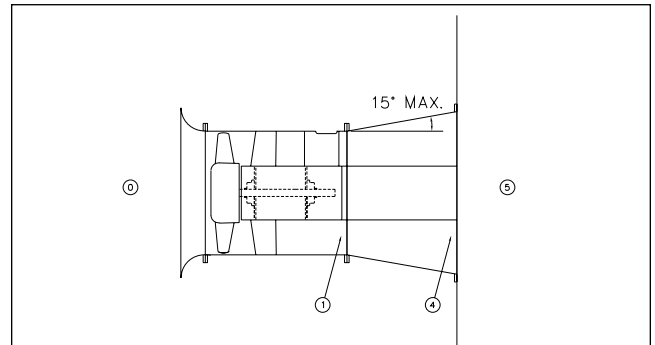

## Fan Connected to a Non-Ducted Outlet Cone with Center Body

In Figure 6, the duct has been removed from the Figure 5 setup. For this case the equation for impact loss is:

$$IP_6 = \rho \left( \frac{V_4}{1096.2} \right)^2 + \rho (1-\eta) \left[ \left( \frac{V_1}{1096.2} \right)^2 - \left( \frac{V_4}{1096.2} \right)^2 \right]$$

$$IP_6 = 0.92 \text{ in. w.g.}$$

$$Pt_5 = Pt_1 - IP_6 = 6.05 - 0.92 = 5.13 \text{ in. w.g.}$$

$$Ps_5 = Pt_5 - Pv_5 = 5.13 \text{ in. w.g.}$$

As in Figure 3, the expansion at the end of the cone is so abrupt that all of the energy due to the velocity pressure at station 4 is lost. Since the velocity at the abrupt expansion is lower than Figure 3, the energy loss is lower. In the Figure 3 setup, 11 hp was lost. In this case, the impact loss is 0.92 in. w.g. at 25,000 cfm, so 3.6 hp is lost.

Figure 7. Axial Fan Connected to a Ducted Inlet and Outlet Cone with Center Body

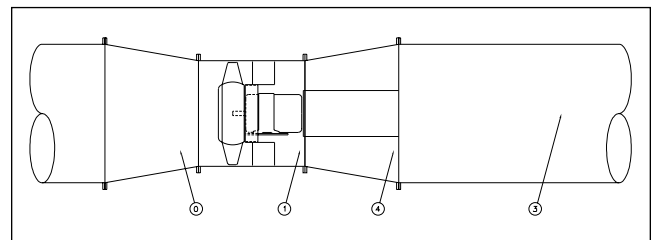

## Summary

In all of the examples, the flow rate and fan speed remained the same. The table below summarizes how this fan works on the different system configurations.

Figure	Description	CFM	SP (in. w.g.)
1	Duct Diameter = Fan Diameter (AMCA Test)	25,000	4.50
2	Duct Diameter > Fan Diameter (Abrupt Expansion)	25,000	4.56
3	Plenum	25,000	3.22
4	Ducted Outlet Cone w/o Center Body	25,000	5.17
5	Ducted Outlet Cone w/ Center Body	25,000	5.27
6	Non-Ducted Outlet Cone w/ Center Body	25,000	5.13

### Example

This example shows how the equations and figures above can be applied to a different fan and system requirement. A 24" diameter vaneaxial fan is going to be used in a system requiring 16,000 cfm as shown in Figure 7. The calculated duct losses are 3.0 in. w.g. SP at the inlet and 1.0 in. w.g. in the duct downstream of the outlet cone. In this example, the impact loss equation will be the same as Figure 5. Calculate the equivalent fan static pressure for a Figure 1 system in order to use catalog tables or selection software to make the final fan selection.

We are given:

$$\text{ACFM} = 16,000$$

$$\text{SP}_0 = -3.0 \text{ in. w.g.}$$

$$\text{SP}_3 = 1.0 \text{ in. w.g.}$$

In the 36" diameter duct we have:

$$V_0 = V_3 = 2263 \text{ fpm}$$

$$\text{Pv}_0 = \text{Pv}_3 = 0.32 \text{ in. w.g.}$$

$$\text{Pt}_0 = -3.0 + 0.32 = -2.68 \text{ in. w.g.}$$

$$\text{Pt}_3 = 1.0 + 0.32 = 1.32 \text{ in. w.g.}$$

The outlet area for this fan is  $A_1 = 3.16 \text{ ft}^2$ , so we can calculate  $V_1 = 7656 \text{ fpm}$  and  $\text{Pv}_1 = 3.65 \text{ in. w.g.}$  With the inner shell diameter of 14 inches, we can calculate the velocities and velocity pressures at stations 4 and 1.

$$A_4 = \pi/4(36^2 - 14^2) = 864 \text{ in}^2 = 6 \text{ ft}^2$$

$$V_4 = 2667 \text{ fpm}$$

$$A_1 = \pi/4(24^2 - 14^2) = 298 \text{ in}^2 = 2.07 \text{ ft}^2$$

$$V_1 = 7719 \text{ fpm}$$

Using the equation for impact loss for Figure 5:

$$\text{IP}_5 = \rho \left( \frac{V_4 - V_3}{1096.2} \right)^2 + \rho (1-\eta) \left[ \left( \frac{V_1}{1096.2} \right)^2 - \left( \frac{V_4}{1096.2} \right)^2 \right]$$

$$\text{IP}_5 = 0.59 \text{ in. w.g.}$$

$$\text{Pt}_1 = \text{Pt}_3 + \text{IP}_5 = 1.32 + 0.59 = 1.91 \text{ in. w.g.}$$

To calculate the Figure 1 fan static pressure, we need to use the impact loss equation for Figure 1 and the fan outlet area.

$$A_2 = 3.16 \text{ ft}^2$$

Calculating:

$$V_2 = 5063 \text{ fpm}$$

$$\text{Pv}_2 = 1.60 \text{ in. w.g.}$$

$$\text{IP}_1 = \rho \left( \frac{V_1 - V_2}{1096.2} \right)^2$$

$$\text{IP}_1 = 0.44 \text{ in. w.g.}$$

$$\text{Pt}_2 = \text{Pt}_1 - \text{IP}_1 = 1.91 - 0.44 = 1.47 \text{ in. w.g.}$$

From the AMCA definition of fan static pressure:

$$\text{Psfan} = \text{Pt}_2 - \text{Pt}_0 - \text{Pv} = 1.47 - (-2.68) - 1.60 = 2.55 \text{ in. w.g.}$$

So for this example, you would either go to the performance tables or the selection software and select a fan for 16,000 cfm at 2.55 in. w.g. static pressure.

### Conclusion

These examples demonstrate how duct connections can have a significant effect on fan performance. For fans tested and rated using ANSI/AMCA 210 - ASHRAE 51 methods, use the steps above to calculate the pressures at the various locations.

It should be noted that some foreign fans are rated based on the total pressure at station 1 on Figure 1. While this is not per ANSI/AMCA/ASHRAE standards, their reason for rating in this manner is to make it easier to make the outlet connection calculations. With this type of rating it is not necessary to make the Figure 1 calculations before correcting for a particular duct connection. It should also be noted that rating in this manner does not include the impact loss present in the AMCA ratings (Figure 1), so without consideration of the rating method, fans rated this way will appear to have higher efficiencies.

